



INVESTIGATING THE EFFECT OF CRACK GEOMETRIES AND WELD MISMATCHING IN ORDER TO OPTIMIZE ECA ANALYSIS OF GIRTH WELDED OFFSHORE PIPELINES

S.M.H. Sharifi^{1*,†}, M. Kaveh¹ and H. Saeidi Googarchin²

¹*Department of Offshore Structures Engineering, Faculty of Marine Science, Petroleum University of Technology, 63146- 61118 Abadan, Iran*

²*Automotive Fluids and Structures Analysis Research Laboratory, School of Automotive Engineering, Iran University of Science and Technology, 16846-13114 Tehran, Iran*

ABSTRACT

Offshore pipelines are an effective tool for transportation of oil and gas which are usually assembled by the use of girth welds. Since flaws may naturally exist at such welds, fracture assessment of girth welded offshore pipelines is substantial. Current fracture assessment procedures like BS 7910 consider identical material properties for the weld and the base metals. However the strength difference between weld and base materials has significant effect on fracture assessment results. This effect is magnified greatly for pipelines which are operated in deep waters and are subjected to large plastic loads. In this paper 3D nonlinear elastic-plastic finite element analyses using the ABAQUS software are performed in order to investigate the effect of weld mismatching at various crack geometries on fracture assessment of pipeline's girth weld. It is noteworthy that such a quantitative study on the effect of weld mismatching condition at different crack geometries on ECA analysis has not been performed so far. Based on simulation performed, a new optimized formula is proposed for fracture analysis of girth welded pipeline with surface cracks considering the effect of weld mismatching conditions at plastic strains. The results show that comparison of proposed formula results with those available experimental data reveals a great agreement. Furthermore, it is observed that the effect of strength difference between the base and the weld materials is insignificant for short cracks whereas mismatching plays a more dominating role in long cracks. Also, with increasing the crack heights the effect of weld mismatching raises meaningfully. In addition, ECA analysis results with and without weld mismatching effect are compared.

Keywords: Engineering critical assessment (ECA); offshore pipeline girth weld; surface cracks; weld mismatching; optimized CTOD formula.

*Corresponding author: Department of Offshore Structures Engineering, Faculty of Marine Science, Petroleum University of Technology, 63146- 61118 Abadan, Iran

†E-mail address: sharifi@put.ac.ir (S.M.H. Sharifi)

Received: 30 January 2017; Accepted: 7 April 2017

1. INTRODUCTION

In order to convey oil and gas from the platforms to land-based terminals, offshore pipelines are utilized which are usually composed of a number of short pipes joined by welding. The girth welds may contain weld imperfections of certain size (depth and length) at specific locations along the longitudinal direction of the weld [1]. Therefore, it is important to find a suitable fracture assessment procedure for welded pipelines with defects in the weld zone subjected to different loadings and know the pattern of crack growth in order to assess the structural integrity of the pipelines [2]. For this, two methods were introduced to determine flaw acceptance criteria which are fitness for purpose and quality control approaches. By the principle of fitness for purpose procedure, a particular structure would be designed so as to be adequate for its purpose, provided the conditions to cause failures are not reached. On the other hand, quality control approach monitors and maintains quality during production and considers it for the future condition of product which would usually give both arbitrary and conservative levels for acceptance. In the principle of fitness for purpose procedure, decision of rejection and/or repairs is justified whether based on previous documented experiences (workmanship criteria) or on the basis of Engineering Critical Assessment (ECA) [3]. ECA is a defect acceptance criterion based on fracture mechanics principles and was introduced by Kumar et al in 1981[4]. They proposed an analytical methodology for computing crack driving force based on J-Integral. Their methodology was published by Electric Power Research Institute (EPRI). The EPRI equations for fully plastic condition suppose a simple power law for plastic stress-strain behavior of material [4]. Anisworth [5] modified the EPRI relations in order to make them more representative of the flow behavior of real materials. He defined a reference stress approach and substituted it to the plastic component of EPRI procedure in order to characterize the possibility of plastic collapse along the fracture failure. With additional simplifications and modifications to the reference stress approach, BS7910 expresses it in terms of a Failure Assessment Diagram (FAD). This approach which is suited to load controlled situations is called stress-based ECA. Stress-based ECA is not exactly applicable when the applied longitudinal stress exceeds the yield strength of the pipe. However, there are several situations, where the pipeline girth welds are subjected to large plastic strains typically in the range of 1–3 %. Under such displacement controlled conditions, load-based fracture assessments may result in allowable plastic strain limits which are too small, or would lead to impractical designs [6].

A vast majority of research efforts has been done in order to study the effect of various parameters on ECA of flawed pipeline girth welds subjected to large plastic strains. Zhang et al. [7-9] carried out comprehensive nonlinear elastic–plastic studies and presented the influence of loading path, crack position, and internal pressure in large plastic bending, tension, and biaxial loading conditions. Pisarsky [10] and Jayadevan et al [11] showed that in the presence of internal pressure in addition to axial strain, crack driving force would meaningfully increase. In other words, the deformation capacity of the cracked pipe would significantly reduce under biaxial loading. Studying the effect of loading situation on fracture response variation, Ostby et al. showed that up to medium strain levels, the CTOD-strain relation for bending case slightly varies from that for tension [12].

Extensive studies have been performed in order to introduce a set of closed-form solutions to

predict the failure in structures. An analytical weld toe magnification factor was proposed by Han et al [13] for efficient calculation of the stress intensity factors. This factor is applicable to complex geometrical shapes such as cruciform or T-butt joints. Paredes [14] presented a set of closed-form estimation for assessing the plastic limit load in heterogeneous single edge notch tension specimens in plane strain condition based on excessive FE analyses. Nourpanah and Taheri [15] proposed a new method to improve the J-integral estimation formulas for ECA analysis of reeled pipelines. They obtained a linear relation between J-integral and the strain of un-cracked body. Furthermore, Zhang et al proposed strain-based estimations for fracture assessment of single large crack located in the weldment and also for surface cracks which have interacted with embedded flaws (two collinear cracks) [16, 17].

Some investigations have been conducted in order to compare the guidelines with the results of finite element analysis to improve the accuracy of the standards. Among them, the study of Lie et al [18] and Zhang et al [19] are worthy to be mentioned. In the former study, the authors carried out a comparison between FADs which are extracted for cracked T-joints and Y-joints via finite element method and BS 7910 level 2A curves. It is observed that the assessment results using level 2A curve might be unsafe since some parts of the finite element FADs fall inside the standard one. Offshore pipeline's girth weld with various corroded depths and lengths is simulated in the latter study. They compared their finite element results with ASME-B31G-2012 and DNV-RP-F101 design codes and demonstrated that both standards may produce somewhat conservative estimations on the failure assessment.

While the strength mismatch between the base and weld materials of the pipeline plays a significant role in the process of the pipeline fracture assessment particularly at plastic strains as signified in DNV-OS-F 101 [20], few studies could be found in literature contributed to the investigation of the strength mismatch effect on ECA analysis of girth welded offshore pipelines. Since considering the effect of this parameter is substantial for the modification of the standards, the major novelty of this work is dedicated to present a new formula for ECA analysis of pipeline's girth weld which is considered the effect of strength difference between base and weld metals at various crack geometries.

In this paper, the CTOD evolutions of the 3D external surface cracks in offshore pipeline girth welds are investigated under large plastic operational loading phase. In Section 2, geometrical configurations, material properties of pipeline, loading scenarios, and finite element meshing technique are illustrated in details. In section 3, the effect of crack geometries and weld mismatched condition on CTOD values are presented. Utilizing a nonlinear elastic-plastic fracture analysis, a new flaw assessment formula for the evaluation of CTOD values is proposed considering the effect of weld mismatching condition at different crack geometries. Afterward, a comparison of the fracture assessment between BS7910, finite element analysis with and without considering the effect of strength mismatch is presented in Section 4. Finally, a summary of the results and conclusions are given in the last section.

2. METHODOLOGY

2.1 Geometry configurations

Nonlinear 3-D finite element analyses are performed for circumferentially flaws in pipelines' girth weld. The geometric features of a girth welded pipeline are shown in Fig. 1a. The outer radius of pipeline is 203.2 mm, and the average wall thickness is 20.4 mm. The cross-section of the girth weld is shown in Fig. 1b. As can be seen in Fig. 1c, a canoe shape

surface crack (with its fillet radius equal to the crack depth) is located at the weldment which is believed to be a typical weld-defect in offshore pipelines. However, it is worthy to note that the crack shape does not influence the fracture response at the crack center, where the maximum CTOD occurs [21]. The crack depth is symbolized as " a ", while " $2c$ " represents the crack length. The ratio " c/a " is denoted as the aspect ratio. In order to describe the effect of crack geometrical configurations on fracture response of pipeline's girth welds, three crack depths of 6, 8, 10 mm, and aspect ratios of 1, 3, 5 are considered. In addition, it is noted that only a segment of the pipe with the length of two times the outer diameter was modeled. It is sufficiently long to capture the strain and stress discontinuity caused by the crack recommended by Jayadevan et al. and Øtsby [6, 11].

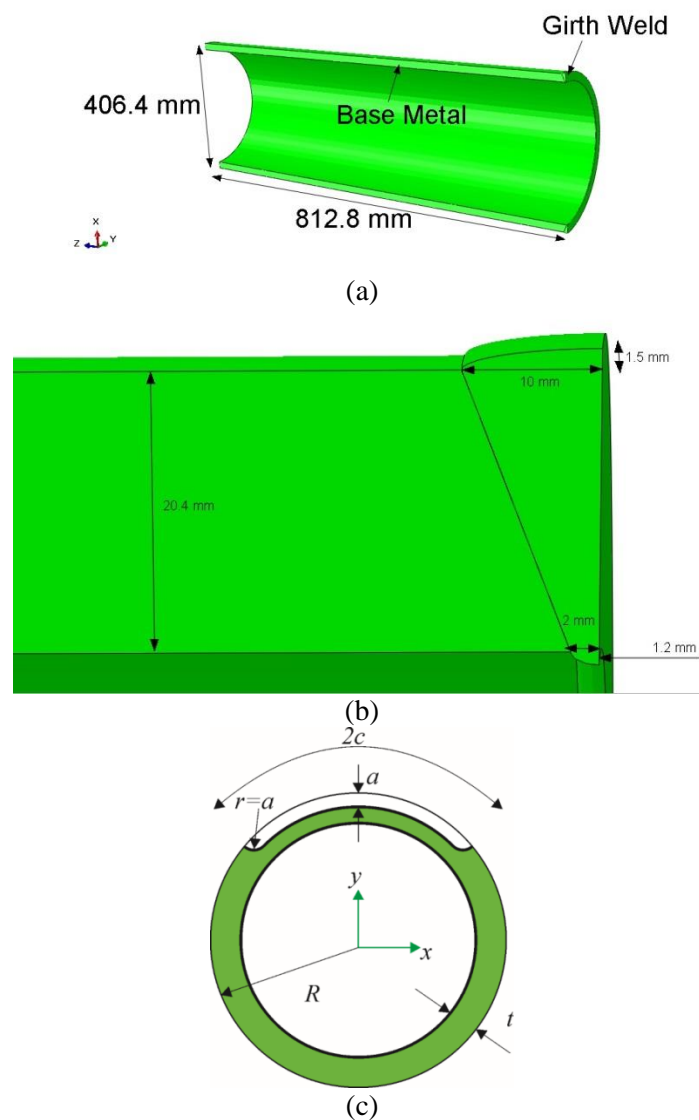

Figure 1. Schematic drawing of the girth welded pipeline: (a) configuration of girth welded pipeline, (b) geometrical dimension of the girth weld section, (b) typical geometry configuration

for cracked cross section

2.2 Material properties

Materials of the pipeline could be divided into the base metal, carbon steel, and the weld metal. API 5L Grade X65 is considered as the base metal of the pipe and for the weld metal, an Inconel filler metal is used. The mechanical properties of the materials used in the pipeline are listed in Table 1.

Table 1: Mechanical properties of materials used in the pipeline (at 150°C)

Material	Young's Modulus E (GPa)	Poisson ratio ν	Yield stress YS (MPa)	Ultimate tensile strength UTS (MPa)
Base metal	207	0.3	545	593
Weld metal	178	0.3	531	622

The CSA Z662 [22] isotropic strain hardening model is selected to produce uniaxial true stress-strain curves for the carbon steel (i.e. base metal) in all finite element models since it can generate a unique hardening exponent for any given set of Yield Stress (YS), Ultimate Tensile Strength (UTS), and uniform ELongation (uEL). CSA Z662 design code defines the nonlinear plastic behavior of material as follows:

$$\varepsilon = \frac{\sigma}{E} + (0.005 - \frac{YS}{E}) \left(\frac{\sigma}{YS} \right)^n \quad (1)$$

where E is Young's modules, YS is the yield stress at 0.5% strain and n represents the strain hardening defined in equation 2 which is 39.25 in current study.

$$n = \ln \left(\frac{uEL - UTS/YS}{0.005 - YS/E} \right) / \ln \left(\frac{UTS}{YS} \right) \quad (2)$$

As for the weld metal, the uniaxial stress-strain relation would be divided into three parts. The first part stands for a straight line of slope E (the Young's modulus). The second part represents the Lüder's expansion, which have a constant stress equal to YS and the third one characterizes the strain hardening of the curve, represented as follows in equation 3:

$$\begin{aligned} \varepsilon &= \frac{\sigma}{E} & \text{if } \varepsilon \leq \frac{YS}{E} \\ \sigma &= YS & \text{if } \frac{YS}{E} < \varepsilon \leq 1\% \\ \varepsilon &= \frac{\sigma}{E} + (0.005 - \frac{YS}{E}) \left(\frac{\sigma}{YS} \right)^n + 0.005 & \text{if } 1\% < \varepsilon \leq uEL \end{aligned} \quad (3)$$

In order to investigate the effect of weld mismatched condition, two different materials are introduced for the girth weld metal. The UTS of current weld metal is 622 MPa, 5% higher than the UTS of base steel which is 592 MPa. That is, the weld has the median value of even-matched strengths according to experimental researches [23], obtaining the

hardening exponent, n , as 24,45. The two more UTS of weld metal called under-matched and over-matched are assumed to be 563 MPa and 681 MPa respectively. The corresponding uniaxial stress–strain curve follows equation 3, yet the hardening exponent n would change which is 22.02 for under-match and 27.23 for over-match situation. Meanwhile, mechanical properties of the base metal are remained constant in all the simulated models.

3.2 Finite element modeling

Finite element simulations are carried out using ABAQUS 6.14 code [24]. Pre-processing, processing, and post-processing of finite element models were executed automatically using an internal script developed which significantly expedited the study. Due to the symmetry, only one-quarter of the pipe was modeled using eight node 3D elements (known as C3D8R).

For large plastic strain analysis, Anderson [25] had recommended the use of finite radius at the crack tip. The initial blunt crack tip should not affect finite element results as long as CTOD value after deformation is at least 5 times the initial value. Therefore, a blunt crack front is modeled with a radius of 0.01 mm (the initial value of CTOD is 0.02 mm). So, finite element analyses with the CTOD larger than 0.1mm are considered to be accurate.

Spider web mesh technique is adopted to simulate blunt crack tip region. Fig. 2 shows a sample finite element model and a close-up view of the near-tip spider web mesh. The crack tip region was modeled with 10 rows of elements covering in the circumferential and radial directions as suggested in literature [26]. In addition, the size of the smallest element around the blunt crack tip is on the order of 0.001 of the crack length. Within the crack tip zone, the number of element rows along the crack line varies from 15 to 30. Hence, each finite element model consists of 21,000 to 32,000 elements depending on the crack size.

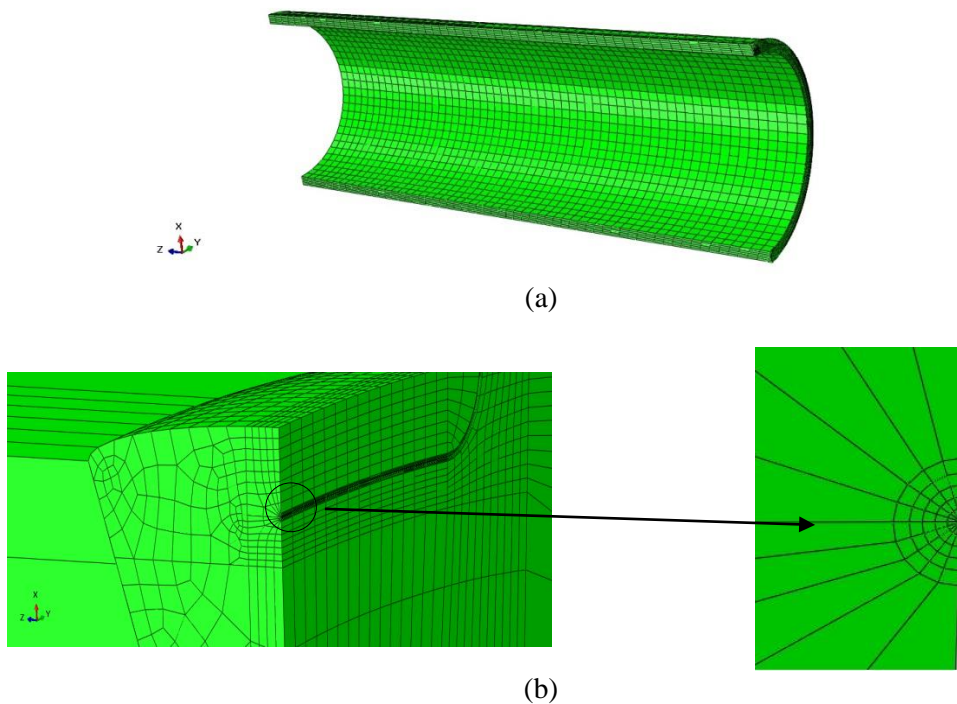

Figure 2. Finite element model and close-up of the near-tip mesh

J2 flow theory of plasticity with isotropic hardening is taken to describe the material behaviors of the carbon steel and the weld metal. The Nlgeom option in ABAQUS software is activated to include the feature of the non-linear geometry in the analysis. Meanwhile, mesh convergence studies were carried out scrutinizing both the global behavior and the J-integral values, providing confidence in the established mesh.

The boundary condition and loading for the model in this study are as shown in Fig. 3: one end of the pipeline segment except the cracked surface is constrained in Z direction and the two surfaces of which the normal direction is the X axis are not allowed to move along this axis. Biaxial loading including tensile axial loading at the un-cracked end of the pipeline segment with internal pressure (15 MPa) are considered. The loading process includes two steps: first the internal pressure is exerted on the inner surface of the pipe. Then, the tensile displacement would be imposed in the next step. Such a subsequent of loading is common in practice and corresponding for generating the worst case [27]. Taking into account the large plastic strains induced to offshore pipelines, the maximum global strain is assumed to be 3% [28].

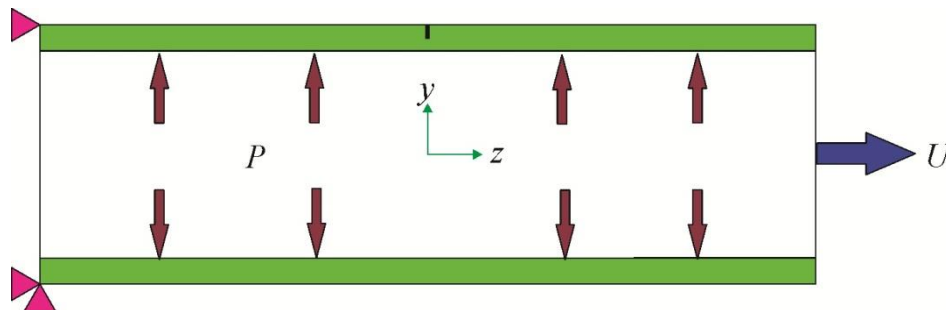

Figure 3. Boundary conditions and a loading scenario considered as representative of High Pressure / High Temperature condition

3. RESULTS AND DISCUSSION

In this section, a validation of the finite element model with the available experimental results is performed. The effects of crack geometrical configuration and weld mismatching condition on fracture assessment of offshore pipeline's girth welds have been investigated. It should be noted that investigation of the influence of crack geometries and strength difference between weld and base materials on the evolution of Crack Tip Opening Displacement (CTOD) as a failure assessment parameter has not been studied quantitatively up to now at the current extension. Furthermore, a new strain-based closed-form formula for CTOD estimation including the effect of strength mismatching is also proposed.

3.1 Validation of finite element model

Finite element results are validated against the full scale experimental tests conducted by Wang et al [23]. They tested two different pipes, known as X65 "high" and "low" YS/UTS pipes. The pipes were of 323.85 mm outer diameter and 12.7 mm wall thickness. The high

YS/UTS pipes had two types of girth welds which were referred to as the even-matched and over-matched welds. The low YS/UTS pipes had one type of weld which overmatched the pipe strength. The tests were performed under both pressurized and non-pressurized conditions. More details of pipe and weld materials may be found in Table 2.

Table 2: Summary of pipe and weld properties used in full scale tests [23]

	X65 High YS/UTS Pipe					X65 Low YS/UTS Pipe			
	Pipe Property		Weld Mismatch at UTS			Pipe Property			Weld Mismatch at UTS
	YS (MPa)	UTS (MPa)	YS/UTS	Evenmatch Weld	Overmatch Weld	YS (MPa)	UTS (MPa)	YS/UTS	
Minimum	514.4	577.8	0.87	-2%	12%	385.4	466.1	0.83	14%
Maximum	566.8	606.1	0.94	9%	18%	444.0	494.4	0.93	25%
Median	544.7	592.3	0.93	5%	15%	426.1	478.5	0.88	16%

It is noteworthy that tests were conducted for median pipe properties. For the cases defined in Table 3, numerical calculations are compared with the full scale experimental data in Fig. 4 and it is revealed that finite element results are in a good agreement. Differences between the measured Tensile Strength Capacities (TSCs) and the predicted TSCs via finite elements could be explained by the strength variation along the length of the pipe. Very smooth stress-strain curves which has happened in strain values beyond approximately 2% would cause a small variation in the strength, leading to a large variation of the measured remote strain even when the flaw behaves consistently as expected.

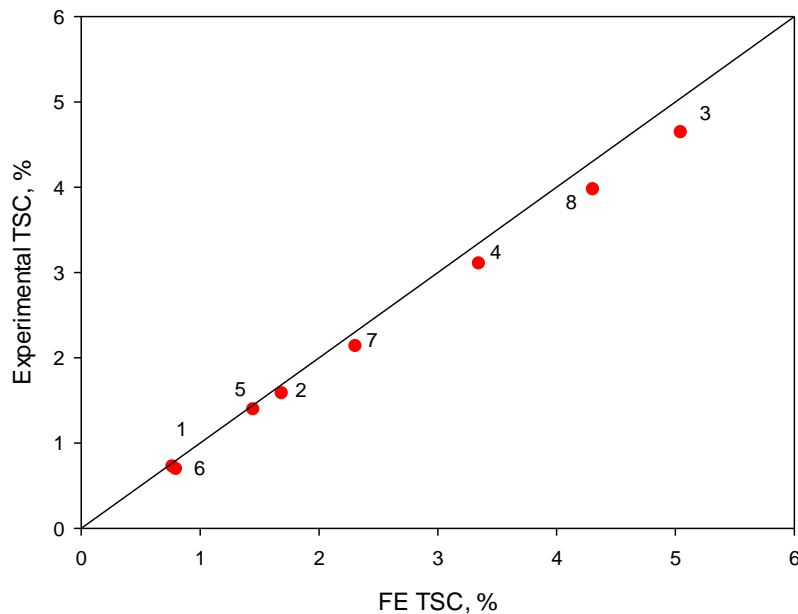

Figure 4. Comparison of Tensile Strain Capacity (TSC) obtained from the present finite element with the full scale tests reported in [23]

Table 3: Input data for comparison between FE and full scale test [23]

Pipe Material	Weld Mismatch	Internal Pressure (MPa)	Crack Depth (mm)	Crack Length (mm)
YS/UTS high	Even	37	3	50
YS/UTS high	Even	37	3	35
YS/UTS high	Even	0	3	35
YS/UTS high	Even	0	3	50
YS/UTS high	Over	37	3	50
YS/UTS high	Over	37	2	70
YS/UTS high	Over	37	3	35
YS/UTS low	Over	32	3	50

3.2 Influence of crack geometry on CTOD

Evolution of CTOD with respect to strain is investigated in order to present the effect of crack geometrical parameters on fracture response of surface cracks at girth welds. In Fig. 5, CTOD-strain curves are obtained for 3 different crack depth (6, 8, 10 mm) and aspect ratios (1, 3, 5) when the strength of the weld and the base metals are in even-match condition.

From Fig. 5a, it can be seen that in the case of shallow cracks ($a=6$ mm), marginal difference between the case of $c/a=1$ and the case of $c/a=3$ indicates that the effect of crack length on the fracture response of shallow surface cracks is minimal. However, when c/a is equal to 5, CTOD evolution has dramatic changes and the increase could be as high as four times in the region of 3% of global strain. Nonlinear and rapid increases could be observed in the region of 0.5% to 2.5% plastic strains but the increase is in mild manner for higher strains. Moreover, in Fig. 5b and 5c, the observation shows that, the effect of crack length becomes more pronounced for the case of $c/a=1$ and 3 when the crack depth is increased to reach moderate and high values (8 and 10 mm), resulting in much higher CTOD sizes. Furthermore, it can be found from Fig. 5 that the curve of CTOD versus strain becomes higher with the increasing in crack depth values

In addition, results revealed that in all crack depths, circular cracks ($c/a=1$) play no considerable role in changing CTOD values comparing to semi-elliptical cracks ($c/a>1$). In other words, the fracture response of circular cracks is not affected by geometrical configuration significantly.

As a result, it can be demonstrated that with increasing in crack depth, the fracture response of external short surface cracks is significantly affected by the crack length. However, long cracks even with shallow depth have high CTOD values. Meanwhile, with increasing in crack depths, the amounts of CTOD values are also intensified.

Moreover, it can be mentioned that with an increase in aspect ratio, the amount of CTOD would also increase, indicating that elliptical cracks at girth welds have larger CTODs compared to the pipelines containing a circular crack.

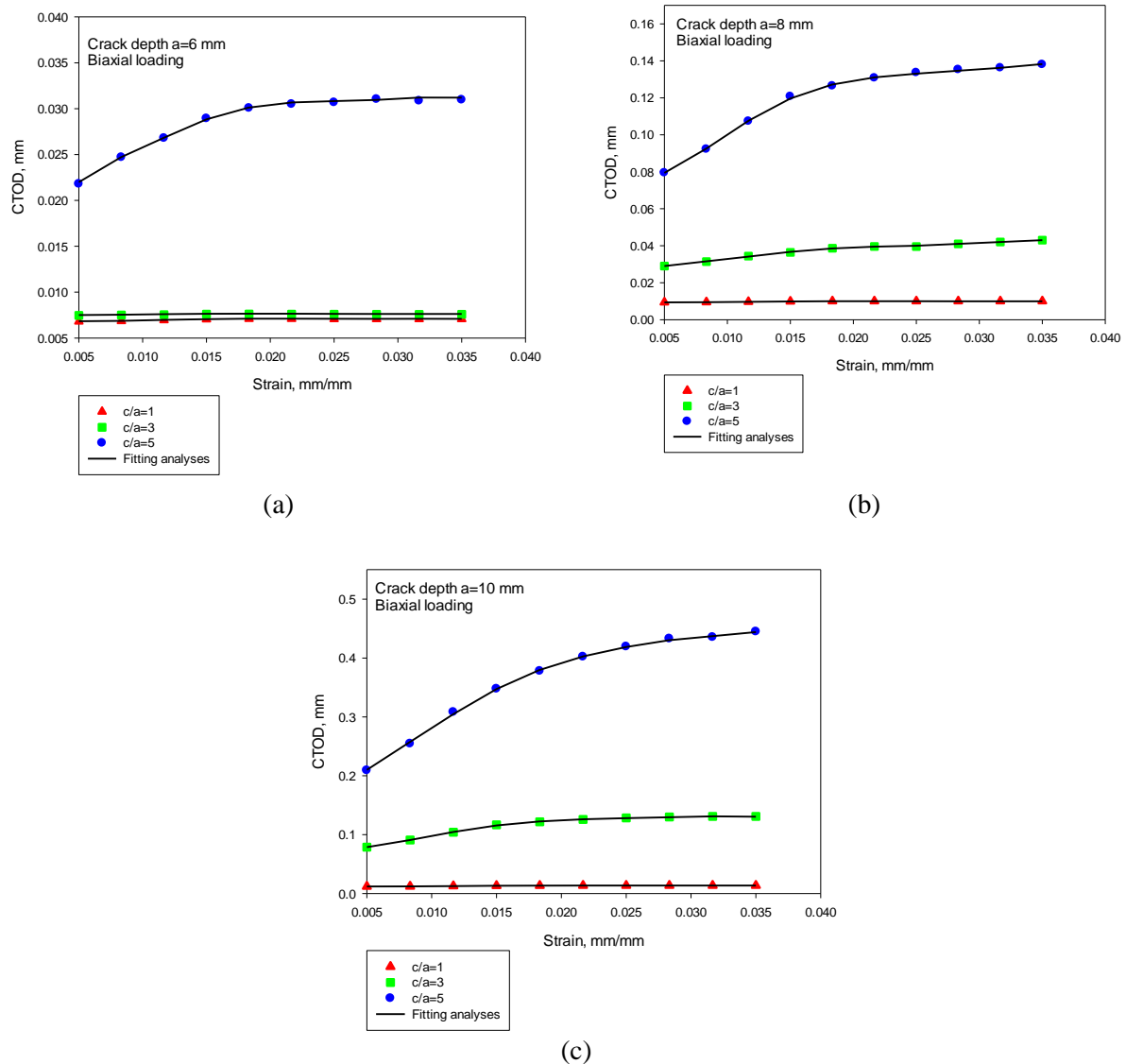

Figure 5. Comparisons of the CTOD values for different aspect ratios at crack depth: (a) $a=6\text{mm}$, (b) $a=8\text{mm}$, (c) $a=10\text{mm}$

3.3 Influence of weld strength mismatching on CTOD

In order to demonstrate the effect of weld mismatching on fracture response, three different crack depths and aspect ratios are compared at two scenarios of strength mismatch conditions which are under-matched and over-matched strengths with the UTS of 563 and 681 MPa for weld metal respectively. CTOD evolutions are investigated in details by the use of nonlinear elastic-plastic analysis.

Considering under-match condition, the comparison of CTOD values obtained from $c/a=1$, 3, and 5 are presented in Figs. 6a-c. Meanwhile, CTOD values for over-match situation are shown in Fig. 6d-f for the same c/a cases.

It can be observed in Fig. 6 that the CTOD values which are obtained in the under-matching cases are always higher than the corresponding over-match values. Also, the difference between CTOD values for under-match and over-match situation for $c/a=1$ is not considerable in all crack depths. It is indicating that the effect of strength difference between base and weld materials is insignificant for circular cracks. For semi-elliptical cracks ($c/a>1$), CTOD values are significantly augmented in under-match condition compare to over-match situation which imply that semi-elliptical cracks are more affected by weld mismatching in comparison with circular cracks. It is revealed that the difference between under-match and over-match fracture response for shallow cracks ($a=6$ mm) is less than moderate and deep cracks ($a=8, 10$ mm). However, in the case of later cracks the difference between mismatching condition CTOD values is almost constant for each crack depth at different c/a ratios.

Furthermore, it is found that in a specific crack depth the difference between mismatching conditions (under-match and over-match) is increase with increasing in aspect ratios.

Consequently, it is found that the values of CTOD are always greater in under-matched condition than over-matched situation which would reveal that although the strength of material would be lower in under-matched condition, but it has larger amount of ductility. In addition, although in the case of circular crack ($c/a=1$) the amount of CTODs in both mismatching situations is almost identical, the difference between over- and under-matched conditions is increased dramatically for semi-elliptical cracks at the same crack depths. However, the difference between mismatching conditions in a specific crack depth is almost identical for semi-elliptical cracks at different aspect ratios.

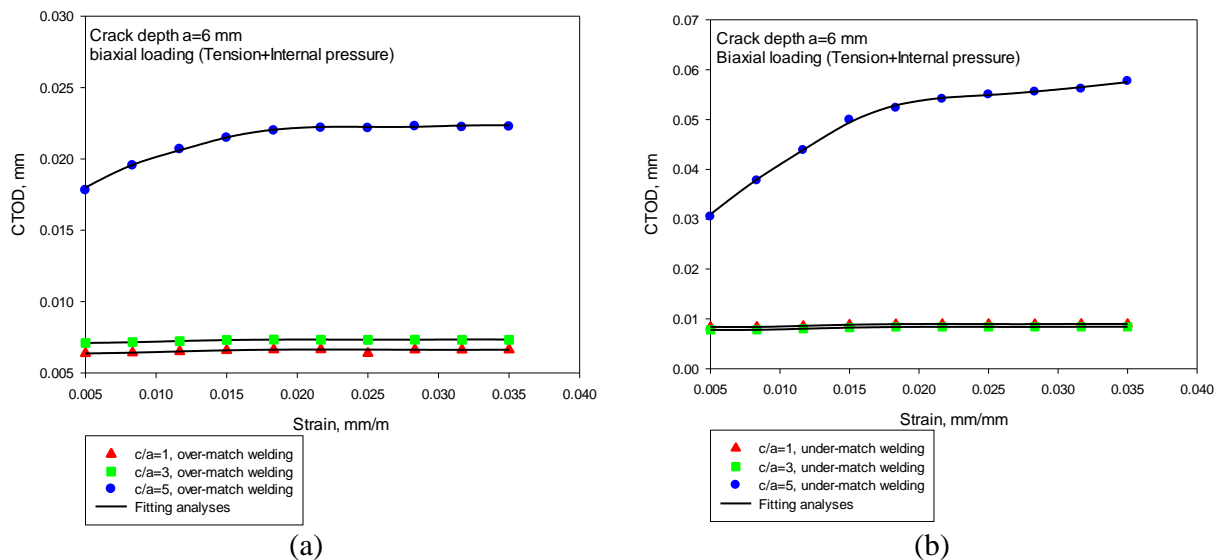

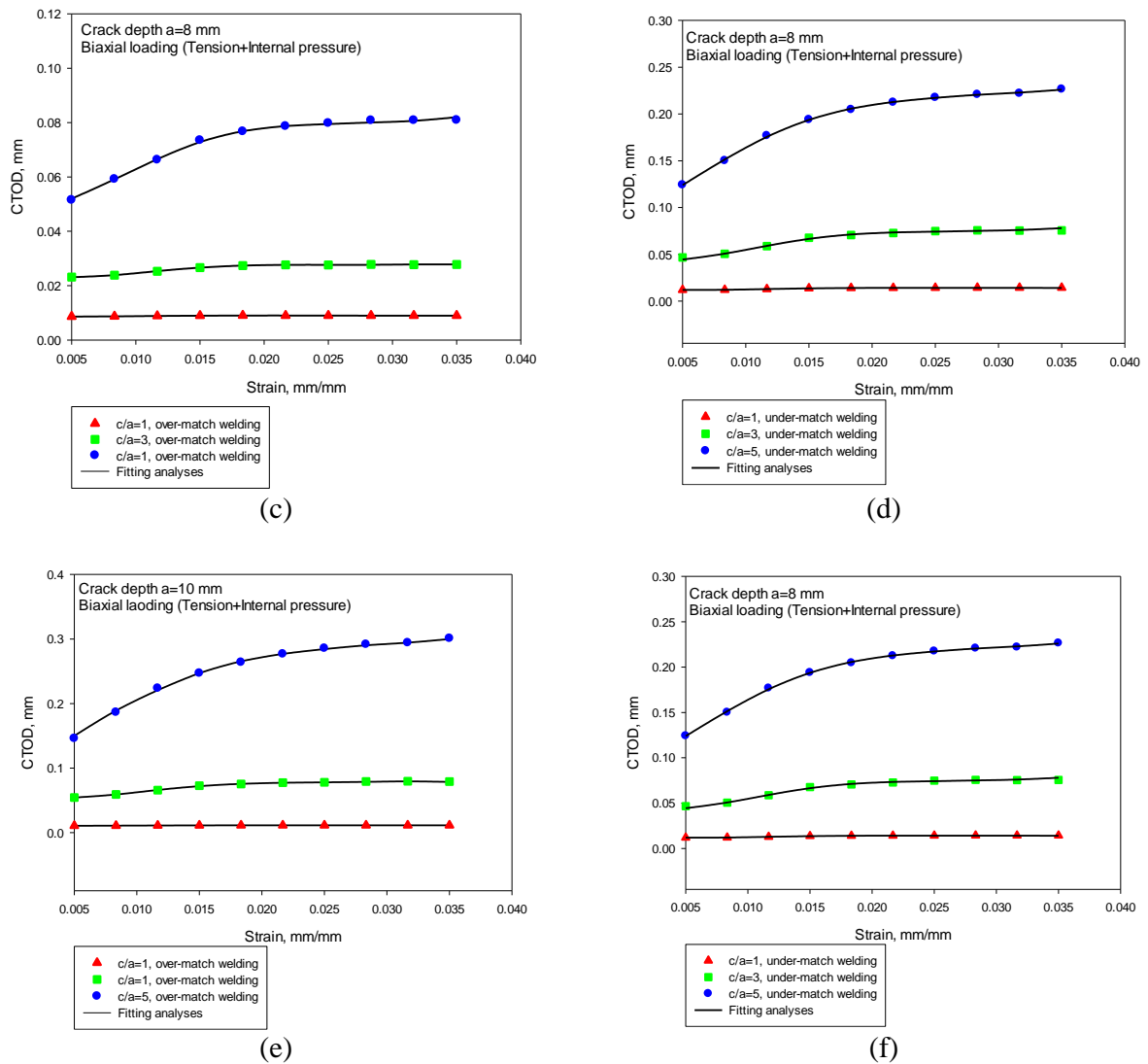

Figure 6. Comparisons of CTOD values for weld metal under-match condition at crack depth: (a) $a/t=0.3$, (b) $a/t=0.4$, (c) $a/t=0.5$, and weld metal over-match condition at crack depth: (d) $a/t=0.3$, (e) $a/t=0.4$, (f) $a/t=0.5$

For a better illustration of the effect of weld mismatching on fracture assessment of pipeline in large plastic strains, comparisons of numerical results with and without considering strength mismatch effect and BS 7910 are made for a crack depth of 10 mm and c/a of 5.

It should be noted that all curves are of the same increasing trend as the strain rises in Fig. 7. However, the CTOD values estimated by BS 7910 are lower than the results with and without considering weld mismatching, indicating that using this guideline can produce somewhat un-conservative predictions at large plastic strains.

In addition, it can be found that compared to even-match condition, the deviations obtained from FE results without considering strength mismatch effect exhibit almost marginal larger values, showing that results without the effect of strength mismatch will not produce very

conservative predictions of fracture behavior in comparison with even-match situation.

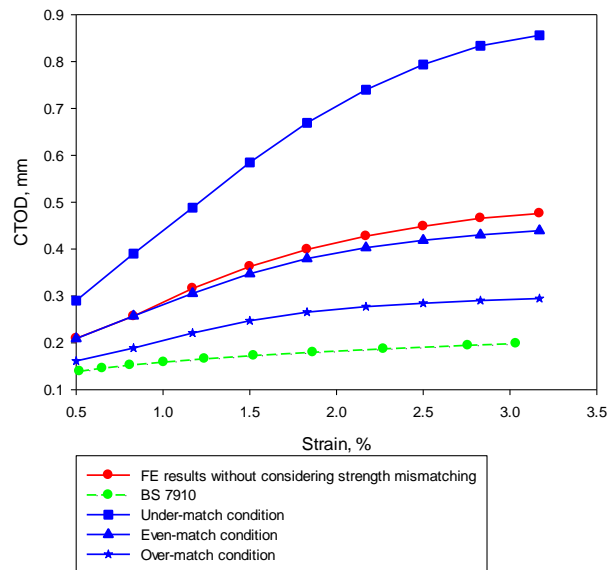

Figure 7. Comparisons of numerical results with and without considering strength mismatch effect and BS 7910 when the crack depth is 6mm and c/a is 5

Furthermore, it can be observed that the numerical results without considering mismatch effect are between the ones predicted for over-match and under-match conditions. In the other word, the values of over-match condition are lower than FE results without mismatching which means that there is a degree of safety in fracture assessment of over-matched girth welded pipelines when mismatching is not considered and under-match condition is upper than FE results without considering the mismatching effect which shows the significant effect of strength mismatching between the base and the weld materials on ECA analyses of offshore pipelines when the strength of weld metal is lower than the base material. Hence, ignoring the effect of strength mismatch at under-match condition cause results to be inaccurate.

3.4. Optimized CTOD estimation method

The difference between strength of the weld and the base metals at various crack geometrical configuration has a meaningful effect on fracture behavior of surface cracks particularly at plastic strains which is not considered at current codes and guidelines. Therefore, it is necessary to present a new formula for ECA analysis containing the effect of weld mismatching conditions.

Strain-based CTOD estimation is presented based on current numerical results for ECA of girth welded offshore pipelines. Two main reasons for using the strain-based approach are: (1) it has been widely pursued in order to investigate the structures subjected to large plastic deformation. (2) To consider the effect of strength difference between the weld and the base metal on fracture response, which is not considered in the current guidelines.

CTOD–strain curves represent nonlinear behavior which could practically be observed in under-match conditions. The polynomial regression is chosen accordingly to exhibit the CTOD estimation as follows:

$$CTOD = A_0\varepsilon^5 + A_1\varepsilon^4 + A_2\varepsilon^3 + A_3\varepsilon^2 + A_4\varepsilon + A_5 \quad (4)$$

where A_0, A_1, A_2, A_3, A_4 and A_5 are regression coefficients represented in Table 4, which depend on the crack geometrical configurations, weld mismatching condition and loadings.

Table 4: The values of A_0, A_1, A_2, A_3, A_4 , and A_5 in Eq. (4) for surface cracks in mismatching condition

a/t		A_0	A_1	A_2	A_3	A_4	A_5
	$UTS_{WM}/UTS_{BM} = 0.95$						
	c/a						
	1	-872419	96671	- 3998.6	74.301	- 0.5615	0.0098
	3	-820113	91245	- 3786.7	70.402	- 0.526	0.0091
	5	-2E+07	2E+06	- 80543	1452.6	- 10.12	0.0591
	$UTS_{WM}/UTS_{BM} = 1.05$						
0.3	c/a						
	1	-311192	34174	- 1386	24.669	- 0.1669	0.0072
	3	-121361	13681	- 555.56	9.4553	- 0.0541	0.0076
	5	-6E+06	649828	- 26974	498.46	- 3.5374	0.0323
	$UTS_{WM}/UTS_{BM} = 1.15$						
	c/a						
	1	-247325	26286	- 1024.3	17.244	- 0.1041	0.0073
	3	-158212	18422	- 784.22	14.292	- 0.0897	0.0065
	5	-2E+06	276158	- 11360	204.66	- 1.3519	0.022
	$UTS_{WM}/UTS_{BM} = 0.95$						
	c/a						
	1	-3E+06	298326	- 12125	221.14	- 1.6012	0.0158
	3	-2E+07	2E+06	- 91138	1631.2	- 10.702	0.0694
	5	-2E+07	2E+06	- 73201	938.68	3.3297	0.0919
	$UTS_{WM}/UTS_{BM} = 1.05$						
0.4	c/a						
	1	-490561	57263	- 2458.4	45.949	- 0.3193	0.0101
	3	-4E+06	521880	- 23100	448.81	- 3.1265	0.0375
	5	-2E+07	3E+06	- 99742	1631.6	- 7.2002	0.0856
	$UTS_{WM}/UTS_{BM} = 1.15$						
	c/a						
	1	-241932	27001	- 1090.6	18.433	- 0.0968	0.0088
	3	-3E+06	385280	- 15749	281.28	- 1.8171	0.0269
	5	-1E+07	2E+06	- 62718	1091.3	- 6.2669	0.065

$UTS_{WM}/UTS_{BM} = 0.95$							
c/a							
	1	-4E+06	439384	- 18513	347.77	- 2.5372	0.0226
	3	-3E+07	3E+06	-107224	1589	-1.629	0.1072
	5	-1E+08	1E+07	- 466774	8916	- 48.301	0.3953
$UTS_{WM}/UTS_{BM} = 1.05$							
c/a							
0.5	1	-2E+06	192722	- 7739.2	138.03	- 0.9548	0.0142
	3	-2E+07	2E+06	- 85439	1391.4	- 5.8098	0.0824
	5	-6E+07	6E+06	- 239886	4181.8	- 18.331	0.2324
$UTS_{WM}/UTS_{BM} = 1.15$							
c/a							
	1	-425241	46296	- 1834.7	30.565	- 0.1553	0.0108
	3	-2E+07	2E+06	- 66391	1141.4	- 6.6979	0.0666
	5	-4E+07	5E+06	- 180661	2973.8	- 12.064	0.167

As shown in Figs. 6 and 7, fitting curves obtained from equation 4 provide an excellent agreement with the present numerical results. This would demonstrate that the proposed CTOD estimation method is reasonably accurate for mismatching conditions. Therefore, the proposed formula would be of use in practical engineering applications.

4. CONCLUSION

In the present study, fracture assessment of a pipeline’s girth weld with surface cracks subjected to large plastic tensile strains has been performed through 3D elastic–plastic finite element models. The combined effect of the crack depth, the crack aspect ratio and the strength difference between weld and base metals on the evolution of CTOD values is investigated. It is noteworthy that such a quantitative study with considering combined effect of above mentioned parameters has not been performed so far. It is believed that, the models were used would cover many of the practical combinations relevant to offshore pipelines.

The major improvement of the current study is a new fracture assessment procedure for the girth welded pipeline with surface cracks considering weld mismatching effect at various crack geometrical configuration. The new formulation can be of use in practical engineering applications; however it has not been presented in any codes and guidelines until now.

The comparison of numerical simulation results with those available experimental data in literature reveals a strong agreement. The most important conclusions of the current study are made as follows:

- The amount of CTOD is increased with the enlargement of the aspect ratio for all crack depths, indicating that elliptical cracks at girth welds have larger CTODs compared to the pipeline's girth welds containing a circular surface crack.
- The deeper the crack depths, the higher the CTOD values for a specific aspect ratios.

- Comparing with short and moderate crack depths, the fracture response of the external surface cracks is more affected by crack length in deeper cracks.
- Under-matched condition would produce greater CTOD values comparing to the over-matched situation, revealing that although the strength of the weld material would be lower in under-matched condition but it behaves in a more ductile manner
- Semi-elliptical cracks are more affected by weld mismatching in comparison with circular cracks in different crack depths.
- The difference of CTOD values between mismatching scenarios is significantly amplified for deep and moderate cracks comparing to shallow crack depths.
- The effect of mismatching has also been investigated in a comparison of numerical results with and without considering strength mismatch effect and BS 7910.
- Although the proposed CTOD estimation considering the effect of mismatching in plastic strains would be of use in practical engineering applications, it has not been covered in any available code and standards so far.

REFERENCES

1. Dake Y, Sridhar I, Zhongmin X, Kumar SB. Fracture capacity of girth welded pipelines with 3D surface cracks subjected to biaxial loading conditions, *Int J Pressure Vessels Piping* 2012; **92**(11): 115-26.
2. Yi D, Idapalapati S, Xiao ZM, Kumar SB. Fracture analysis of girth welded pipeline with 3D embedded subjected to biaxial loading conditions, *J Eng Fracture Mech* 2012; **96**: 570-87.
3. BS 7910. Guide on methods for assessing the acceptability of flaws in metallic structures, BSI, 2005.
4. Kumar V, German MD, Shih CF. An engineering approach for elastic-plastic fracture analysis. EPRI Report NP-1931. Palo Alto (CA): Electric Power Research Institute, 1981.
5. Ainsworth RA. The assessment of defects in structures of strain hardening material, *Eng Fracture Mech* 1984; **19**(4): 633-42.
6. Østby E. Fracture Control - Offshore Pipelines: New Strain-Based Fracture Mechanics Equations Including the Effects of Biaxial Loading, Mismatch, and Misalignment, *24th International Conference on Offshore Mechanics and Arctic Engineering*, Halkidiki, Greece, June 12-17, 2005.
7. Zhang YM, Xiao ZM, Zhang WG. On 3-D crack problems in offshore pipeline with large plastic deformation, *J Theoret Appl Fracture Mech* 2013; **67**, 22-8.
8. Zhang YM, Yi DK, Xiao ZM, Huang ZH. Engineering critical assessment for offshore pipelines with 3-D elliptical embedded cracks, *J Eng Failure Anal* 2015; **51**: 37-54.
9. Zhang YM, Yi DK, Xiao ZM, Huang ZH, Kumar SB. Elastic-plastic fracture analyses for pipeline girth welds with 3D semi elliptical surface cracks subjected to large plastic bending, *Int J Pressure Vessels Pip* 2013, **105**: pp. 90-102.
10. Pisarski H. Assessment of flaws in pipe girth welds, *Welding of high strength Pipeline Steels International Seminar*, Araxa, Brazil, 28-29 November, 2011.
11. Jayadevan KR, Østby E, Thaulow C. Fracture response of pipelines subjected to large plastic deformation under tension, *Int J Pressure Vessel Pip* 2004; **81**: 771-83.

12. Østby E, Jayadevan KR, Thaulow C. Fracture response of pipelines subject to large plastic deformation under bending, *Int J Pressure Vessel Pip* 2005; **82**: 201-15.
13. Han JW, Han DK, Han SH. Stress intensity factors for three-dimensional weld toe cracks using weld toe magnification factors, *J Fatigue Fracture Eng Mater Struct* 2014; **37**: 146-56.
14. Paredes M. Plastic limit load and its application to the fracture toughness testing for heterogeneous single edge notch tension specimens, *J Fatigue Fracture Eng Mater Struct* 2014; **37**: 265-79.
15. Nourpanah N, Taheri F. Development of a reference strain approach for assessment of fracture response of reeled pipelines, *J Eng Fracture Mech* 2010; **77**: 2337-53.
16. Zhang YM, Ariffin MZ, Xiao ZM, Zhang WG, Huang ZH. Nonlinear elastic-plastic stress investigation for two interacting 3-D cracks in offshore pipelines, *J Fatigue Fracture Eng Mater Struct* 2015; **38**: 540-50.
17. Zhang YM, Xiao ZM, Zhang WG. On 3-D crack problems in offshore pipeline with large plastic deformation, *Theoretic Appl Fracture Mech* 2013; **67**: 22-8.
18. Lie ST, Li T, Shao YB. Plastic collapse load prediction and failure assessment diagram analysis of cracked circular hollow section T-joint and Y-joint, *J Fatigue Fracture Eng Mater Struct* 2014; **37**: 314-24.
19. Zhang YM, Tan TK, Xiao ZM, Zhang WG, Ariffin MZ. Failure assessment on offshore girth welded pipelines due to corrosion defects, *Journal Fatigue Fracture Eng Mater Struct* 2016; **39**: 453-66.
20. DNV-OS-F101. Offshore Standard – Submarine Pipeline Systems, Det Norske Veritas, Hovik, Norway, 2012.
21. Raju IS, Newman JC. Stress-intensity factors for internal and external surface cracks in cylindrical vessels, *J Pressure Vessel Technol* 1982; **9**: 104-293.
22. CSA Z662. Oil and Gas Pipeline Systems, Canadian Standards Association, 2007.
23. Wang YY, Liu M, Song Y, Horsley D. Tensile strain models for strain-based design of pipelines, *Proceedings of the ASME 2012 31st International Conference on Ocean, Offshore and Arctic Engineering*, OMAE2012, Rio de Janeiro, Brazil July 1-6, 2012.
24. Hibbitt, Karlsson, Serensen, Inc., ABAQUS/STANDARD. User's Guide and Theoretical Manual, Version 6.14, 2014.
25. Anderson TL. *Fracture Mechanics Fundamentals and Applications*, 3rd edition, CRC Press, 2005.
26. McMeeking R, Parks DM. On criteria for j-dominance of crack tip fields in large-scale yielding. In: Landes JD., Begley JA, Clarke GA. editors. Elastic-dominant fracture, ASTM STP 668. Philadelphia: ASTM International, 1979, pp. 175.
27. DNV-RP-F108. Recommended practice – fracture control for pipeline installation methods introducing cyclic plastic strain, Det Norske Veritas, Hovik, Norway, 2006.
28. Chattopadhyay J, Kushwaha HS, Roos E. Improved integrity assessment equations of pipe bends, *Int J Pressure Vessels Pip* 2009; **86**: 454-73.