



## OPTIMAL DESIGN OF BASE ISOLATION SYSTEM UNDER BLAST LOADING

M. Mohebbi<sup>\*,†</sup> and H. Dadkhah

*Faculty of Engineering, Department of Civil Engineering University of Mohaghegh  
Ardabili, Ardabil, Iran*

### ABSTRACT

In this paper, a design method is proposed for base isolation system under blast loading that this method is based on transforming design problem into an optimization problem. Genetic algorithm has been employed to solve the optimization problem whereas base isolation system properties have been considered as design variables and a linear combination of base drift and inter-story drift has been defined as objective function. A sensitivity analysis has been also conducted to investigate the effect of base isolation system properties on the blast performance of isolated structure. For numerical simulation, base isolation system is designed using the proposed method for controlling the response of an eight-story nonlinear shear-type building frame under blast loading. It has been found from the results that base isolation system is an effective control system under blast loading that its performance is dependent on the base isolation system characteristics especially the base mass. The optimization results also show that base isolation system designed using the proposed method is a well-designed control system for mitigating the blast response of structure and the proposed design method can be considered as an effective design approach under blast loading.

**Keywords:** base isolation system; optimal design; blast loading; base stiffness; base mass; genetic algorithm.

Received: 10 September 2019; Accepted: 21 December 2019

### 1. INTRODUCTION

Earthquake is one of the most important natural hazards which seriously threatens the safety of structures. Structures located in seismic regions usually experience various seismic

---

<sup>\*</sup>Corresponding author: Engineering Faculty, University of Mohaghegh Ardabili, Daneshgah Avenue, Ardabil, Iran

<sup>†</sup>E-mail address: mohebbi@uma.ac.ir (M. Mohebbi)

excitations during their lifetime. Using structural control systems is known as an effective approach for protecting structures against the seismic loading. Base isolation system is one of the most effective passive control systems to mitigate seismic response of structures. In order to achieve the best seismic performance, the optimum design of base isolation system has been investigated in previous researches [1-4].

Although base isolation system is originally proposed for protecting structures against seismic loading, the isolated strategic structures may experience terrorist attacks and blast loadings during their lifetime. Previous researches, which have studied the performance of structures under both blast and seismic loadings, demonstrated that the blast response of structure should be paid attention in the design process [5]. Hence for effective control of isolated strategic structures, the blast loading should be also applied in the design process. The resistance of strategic structures against blast can be even more important than earthquake because a high level of damage induced by explosions not only threatens the human lives but also can cause the fundamental problems for national security.

The previous researches carried out for evaluation of blast performance of structures can be categorized into three groups. In the first group, local damage of structural members has been evaluated [6]. In the second group, progressive collapse of structures against blast loading has been studied [7]. In the third group, it has been assumed that the structural members are designed such that no local damage occurs in the structure and the global response of structure is studied under blast loading [8-10]. The aim of this paper is studying the global response of structure that to this end, blast scenario has been defined such that the probability of local damage occurrence is negligible.

Although the performance of different structures under blast loading has been widely paid attention by researchers, the base isolation system has not been designed for protecting structures against blast loading and only in a few researches, the blast performance of isolated structures has been investigated [11, 12].

In an attempt to address these issues in this paper, the effect of base isolation system properties on the blast performance of isolated structure has been first evaluated through a sensitivity analysis. Particular attention is given to specify base isolation system properties having a significant impact on blast performance of structure and demonstrate high importance of optimal design of base isolation for effective control of structures. The base isolation system is then designed optimally using the proposed method under blast loading. For comparison objectives and validating the proposed design method, the performance of base isolated system designed for seismic loading has been also evaluated under blast loading.

## 2. BLAST LOADING

Blast waves apply extreme pressure on the surface of structure that can cause a significant damage, especially when an explosion device is exploded near the structure. The time history of blast pressure has been investigated through different studies [13] that can be presented using a general shape as shown in Fig. 1.

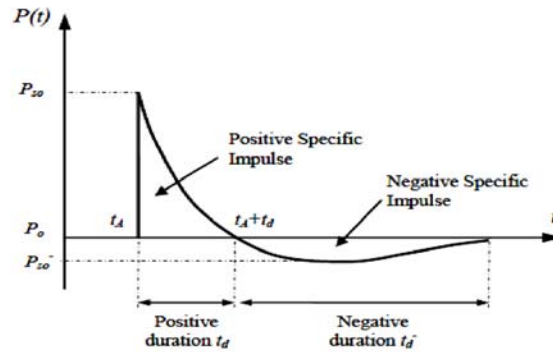

Figure 1. Time history of incident pressure

The blast pressure during time is represented by following equation:

$$p(t) = P_0 + P_{so} \left(1 - \frac{t}{t_d}\right) e^{-bt/t_d} \tag{1}$$

where  $p(t)$  is the blast pressure in time  $t$  which is measured from the instant of  $t_d$ = blast arrival time (see Fig. 1);  $P_0$  is ambient air pressure (101 kPa typically);  $t_d$  is positive phase duration as shown in Fig. 1; the decay coefficient  $b$  is decisive in the extension of the negative phase.  $P_{so}$  is peak incident pressure which the previous researches propose different empirical equations and graphs for calculating it [13]. All of these researches show that the peak incident pressure is function of a scaled distance parameter. This parameter is defined as [13]:

$$Z = \frac{R}{W^{1/3}} \tag{2}$$

where  $R$  is the distance from the explosion source in  $m$ ; and  $W$  is the equivalent weight of TNT in  $kg$ . The blast pressure applied in the design process of structures can be idealized as a combination of several triangular pulses as shown in Fig. 2. The parameters given in this figure have been explained in Unified Facilities Criteria [14] in more detail.

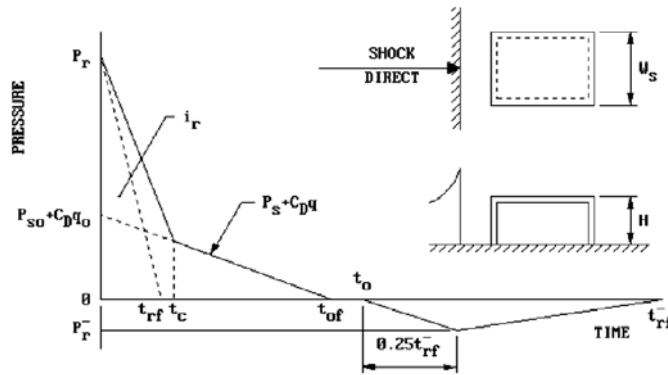

Figure 1. Idealized blast pressure for the structure design

### 3. ISOLATED STRUCTURE MODEL

The idealized dynamic model of an n-story isolated structure has been shown in Fig. 3. The base isolation system considered in this study is lead rubber bearing (LRB) which has been widely used for protecting structures against seismic loading.

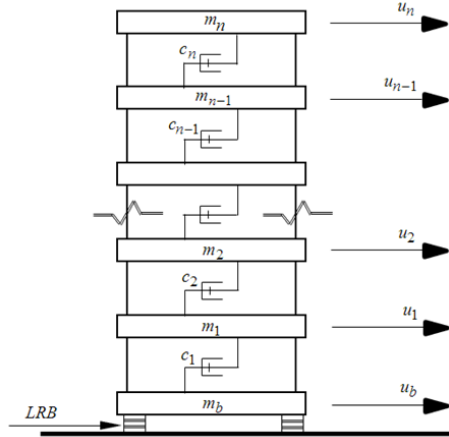

Figure 2. Base isolated structure model

The equation of motion of isolated structure can be written as

$$M\ddot{U}(t) + F_D(\dot{U}(t)) + F_S(U(t)) = F(t) \quad (3)$$

where  $U$ ,  $\dot{U}$ , and  $\ddot{U}$  are respectively the vectors of displacement, velocity and acceleration relative to the ground,  $F_S$  is the vector of restoring force which is a function of displacement and  $F_D$  is the vector of damping force as a function of velocity,  $M$  is the mass matrix of system which is defined as

$$M = \begin{bmatrix} m_b & 0 & \cdots & 0 & 0 \\ 0 & m_1 & \cdots & 0 & 0 \\ \vdots & \vdots & \ddots & \vdots & \vdots \\ 0 & 0 & \cdots & 0 & m_n \end{bmatrix} \quad (4)$$

where  $m_b$  is the base mass, and  $m_i$  is the mass of  $i$ th story. In Eq. (3),  $F$  is the force applied on the structure that for the blast loading, can be defined as

$$F(t) = F_b(t) = P(t)Lh \quad (5)$$

where  $P(t)$  is the vector of blast pressure at different stories of structure,  $L$  is the length of structure which the blast loading is applied, and  $h$  is the height of stories.

The linear behavior is usually used to describe the velocity-force behavior of structure. Hence, the vector of damping force is defined as

$$F_D(\dot{U}(t)) = C\dot{U}(t) \tag{6}$$

where  $C$  is the damping matrix of system which is defined as

$$C = \begin{bmatrix} c_b + c_1 & -c_1 & 0 & \cdots & 0 & 0 & 0 \\ -c_1 & c_1 + c_2 & -c_2 & \cdots & 0 & 0 & 0 \\ \vdots & \vdots & \vdots & \ddots & \vdots & \vdots & \vdots \\ 0 & 0 & 0 & \cdots & -c_{n-1} & c_{n-1} + c_n & -c_n \\ 0 & 0 & 0 & \cdots & 0 & -c_n & c_n \end{bmatrix} \tag{7}$$

where  $c_b$  is the damping of base isolation system, and  $c_i$  is the damping of  $i$ th story.

The force-displacement relationship should be defined in order to determine the restoring force at each time step. It is assumed that the structural elements have been made of a material having the bilinear hysteretic behavior as shown in Fig. 4. The bilinear hysteretic loop is described by an elastic stiffness  $K_1$ , a post-elastic stiffness  $K_2$ , and a yield displacement  $\Delta_y$ .

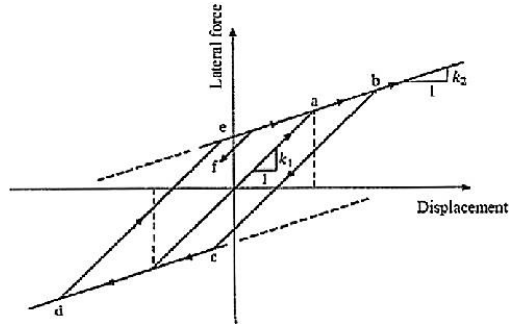

Figure 3. Bilinear elasto-plastic stiffness model

The force-displacement relationship should be also defined for LRB. In recent years, advanced models have been proposed to this end [15]. To avoid complexity in this case study, the bilinear hysteretic model is employed for the force-displacement relationship of LRB that can predict its nonlinear behavior with an acceptable accuracy [16, 17]. However, parameters defined for bilinear model of base isolation system such as the elastic stiffness, the post-elastic stiffness and the yield displacement, is different from the structural elements.

#### 4. OPTIMAL DESIGN OF BASE ISOLATION SYSTEM

In this section, a design approach is proposed for base isolation system under blast loading.

This design approach is based on transforming design problem into an optimization problem that the base isolation system is designed by solving this optimization problem.

The parameters, which can be defined as design variables of LRB, are (1) the base mass  $m_b$ , (2) the elastic base damping  $c_b$ , (3) the elastic stiffness  $k_b$ , (4) the post-elastic stiffness  $k_{b2}$  and (5) the yield displacement  $\Delta_{y_b}$ . The energy dissipation capacity of base isolation system is primarily due to its hysteresis damping and the contribution of elastic base damping  $c_b$  can be neglected. Kumar et al. [15] showed that the effect of base damping on the response of isolated structure is insignificant and concluded that even the elastic base damping can be assumed to be zero for the analysis of LRB, if test data on the elastic base damping is not available. Hence, elastic damping ratio of base isolation is not effective variable in the design process. Assuming 2% of critical damping as the elastic damping ratio of base isolation system, the elastic base damping is defined as

$$c_b = \xi_b \times 2(m_b + \sum_{i=1}^n m_i) \omega_b \quad (8)$$

where  $\xi_b$  is the elastic damping ratio,  $n$  is the number of stories, and  $\omega_b$  is defined as

$$\omega_b = \sqrt{\frac{k_b}{m_b + \sum_{i=1}^n m_i}} \quad (9)$$

Also in order to reduce the design variables, the values of  $\Delta_y$  and  $r = k_{b2}/k_b$  are taken to be 2.5 (cm) and 0.142, as proposed for LRB in previous researches [2, 18]. Finally, the base mass  $m_b$  and the elastic stiffness  $k_{b1}$  are considered as design variables of base isolation system.

To achieve a safe-designed base isolation system, the safety of isolated structure should be provided in two different levels related to superstructure and base isolation system. A large story drift can damage the structural elements and a large base drift at the LRB can create the large over turning moments and cause serious instabilities in the structure. Therefore, a linear combination of maximum story drift and maximum base drift is considered as multi-objective function. Hence the optimization problem for the blast-based optimal design of LRB can be defined as:

Find

$$P = (m_b, k_b) \quad (10a)$$

minimize

$$f = \alpha \frac{\max(d_b)}{D_b} + (1 - \alpha) \frac{\max(d_1, d_2, \dots, d_n)}{D_s} \quad (10b)$$

subject to

$$0.7m_f \leq m_b \leq 1.3m_f \quad (10c)$$

$$k_{\min} \leq k_b \leq k_{\max} \quad (10d)$$

where  $\alpha$  is a constant to represent relative importance between base drift and story drift;  $\max(d_b)$  and  $\max(d_i)$  are respectively the peak base drift and the peak drift of  $i$ th story under blast loading;  $D_b$  and  $D_s$  are defined to make dimensionless the objective function. In this case study,  $D_b$  and  $D_s$  have been respectively defined maximum base drift and maximum story drift under blast loading when the base isolation system is designed based on the common seismic design approach. Designing the base isolation system based on this approach will be explained in the numerical analysis section. A variation domain has been defined for each design variable based on the technical and practical limitations. These variation domains are defined to be around the values proposed by the common seismic design approach. Hence,  $m_b$  is defined a value in intervals  $[0.7m_f, 1.3m_f]$  where  $m_f$  is the floor mass and  $k_b$  is considered such that the fundamental period of the isolated structure is in intervals  $[2T_{fixed}, 4T_{fixed}]$  where  $T_{fixed}$  is the fundamental period of fixed-base structure.

## 5. NUMERICAL ANALYSIS

In this section, a numerical example is conducted to illustrate the effectiveness of proposed design method for base isolation system under blast loading and investigate the effect of control system characteristics on the blast responses of structure. To this end, an eight-story nonlinear shear-type building frame [19] equipped with a base isolation system, as shown in Fig. 3, is subjected to blast loading. A bilinear hysteretic material behavior, as shown in Fig. 4, is considered for the nonlinear behavior of isolated structure where the elastic stiffness  $K_1=3.404 \times 10^5$  (kN/m), the post-elastic stiffness  $K_2=3.404 \times 10^4$  (kN/m) and the yield displacement  $\Delta_y=2.4$  (cm) for each story. The mass and damping of each story are also 345.6 (ton) and 734.3 (kN.s/m), respectively. The reason of selecting shear frame is avoiding more complexity in modeling the structure and determining the blast load. In previous researches [10, 11], different shear frames have been also evaluated under blast loading.

As earlier noted, the bilinear hysteretic model is also used for the force-displacement relationship of LRB. The base mass  $m_b$  and the base stiffness  $k_b$  are considered as design variables and the elastic base damping  $c_b$  is also determined by using Eq. (8) with assuming the damping ratio  $\xi_b = 0.02$ .

For the blast loading, an external explosion with  $W=1000$  (kg) located at distance of  $R=11.3$  (m) has been considered where the minimum scaled distance in first story is equal to  $Z=1.18$  ( $\text{m}/\text{kg}^{1/3}$ ). In previous researches, it has been proven that a safety scaled distance can be determined for a structure such that for a larger  $Z$  than it, the probability of local damage occurrence in the structural elements will be negligible. As instance, Wu and Hao [20] demonstrated that for an eight-story structure, there is no local damage in the structural elements for  $Z \geq 1.18$  ( $\text{m}/\text{kg}^{1/3}$ ). In this study, following the guidelines proposed in previous

researches, the blast scenario has been considered such that the minimum scaled distance is equal to  $Z=1.18$  ( $m/kg^{1/3}$ ) to prevent the local damage and evaluate the global response of structure. The parameters of blast pressure applied on different stories of structure have been determined as recommended by Unified Facilities Criteria [14] and have been presented in Table 1. Assuming the height of stories  $h=3.5$  (m) and the length of structure  $L=30$  (m), the blast loading applied on different stories of structure is shown in Fig. 5.

Table 1: The parameters of blast loading

Story	$R(m)$	$Z$ ( $m/kg^{1/3}$ )	$P_{so}$ ( $kPa$ )	$P_{ra}$ ( $kPa$ )	$q$ ( $kPa$ )	$P_r^-$ ( $kPa$ )	$t_a$ ( $ms$ )	$t_{rf}$ ( $ms$ )	$t_c$ ( $ms$ )	$t_{of}$ ( $ms$ )	$t_o$ ( $ms$ )	$t_{\bar{r}}$ ( $ms$ )
1	11.8	1.18	920	4710	1200	80	6.5	2.23	15.12	4.57	20.5	95
2	13.3	1.33	700	3080	850	64	8	2.60	16.93	5.71	21.0	103
3	15.4	1.54	500	1890	510	51	10.5	3.07	19.06	6.80	20.5	118
4	18.0	1.80	330	726	240	43	15	5.51	21.40	9.09	20.0	112
5	20.8	2.08	250	425	150	40	19	7.53	23.06	10.40	20.0	110
6	23.8	2.38	190	304	100	31	24	9.87	24.52	11.58	21.0	129
7	27.0	2.70	140	217	54	27	30	11.98	25.95	14.29	25.0	119
8	30.2	3.02	120	180	40	22	34	11.67	26.68	15.00	29.0	136

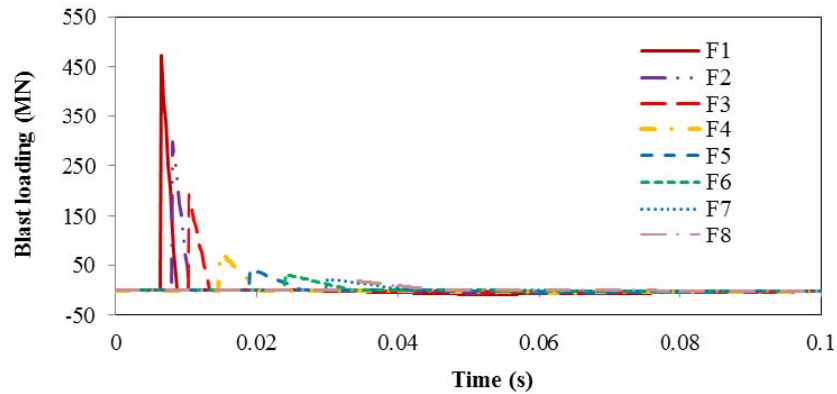

Figure 4. Blast loading applied on different stories

The numerical simulation conducted in this study includes the following sections:

Section (a): blast performance of earthquake-based designed base isolation system

Section (b): effect of base isolation system properties on blast performance of isolated structure

Section (c): blast-based optimal design of base isolation system

### 5.1 Blast performance of earthquake-based designed base isolation system

For comparison objectives and validating the proposed design method, the performance of base isolation system designed based on seismic loading is evaluated under blast loading. The results of this evaluation can also give useful information about the blast performance of earthquake-based designed base isolation system. Hence in this section, the base isolation



system is designed according to the common seismic design approach and the isolated structure is subjected to blast loading. In the common seismic design approach proposed by previous researches and seismic design codes [21], the base mass  $m_b$  is considered almost equal to the floor mass and the base stiffness  $k_b$  is chosen such that the fundamental period of isolated structure is almost triple the fundamental period of the fixed-base structure. The fundamental period of isolated structure can be determined as [21]:

$$T_{iso} = 2\pi \sqrt{\frac{m_b + \sum_{i=1}^n m_i}{k_b}} \quad (11)$$

Hence the base mass  $m_b$  is taken as 345.6 (ton) and the fundamental period of isolated structure is taken about  $T_{iso}=3.255$  (sec) because the first three mode periods of structure are 1.085 (sec), 0.366 (sec) and 0.224 (sec). From Eq. (11), the base stiffness is determined as  $k_b=11.59$  kN/m and the base damping is obtained as  $c_b=240.2$  kN.s/m according to Eq. (8).

The maximum responses of uncontrolled and controlled structures under blast loading have been reported in Table 2 where  $d_b$  and  $d_i$  are the peak base drift and the peak inter-story drift of  $i$ th floor, respectively. The time history response of first story drift and the corresponding hysteretic loop have been also shown in Figs 6 and 7 for uncontrolled and controlled structures.

According to the results presented in Table 2, 29.2% reduction in the peak story drift under blast loading is achieved when the structure is controlled by the base isolation system. The base isolation system also effectively reduces the inelastic response of the fixed-base structure under the blast loading as shown in Fig. 7. As instance, the ductility demand of first story in the fixed-base structure is  $\mu_1 = \Delta_{u1}/\Delta_{y1} = 4.39/2.4 = 1.83$  where  $\Delta_{u1}$  is the peak first story drift whereas the corresponding value is 1.3 for the isolated structure. On the other hand, the peak base drift is also in a desired level and the base isolation systems can usually sustain this drift without damage. Therefore the earthquake-based designed base isolation system has acceptable performance under blast loading but as earlier noted, the resistance of strategic structures against blast can be even more important than earthquake. Hence in this study, the base isolation system is designed optimally under blast loading in order to get the maximum reduction in the base drift and the story drift.

Table 2: Peak responses of uncontrolled and controlled structures under blast loading

Drift (cm)	Fixed-Base Structure	Isolated Structure
$d_b$	-	6.56
$d_1$	4.39	3.11
$d_2$	2.31	2.45
$d_3$	2.14	2.04
$d_4$	2.28	1.65
$d_5$	2.34	1.26
$d_6$	2.38	1.18
$d_7$	2.33	1.20
$d_8$	2.47	1.88

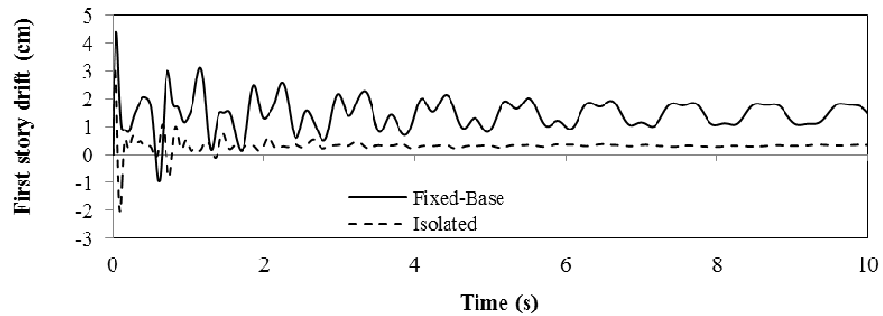

Figure 5. Time histories of first story drift of fixed-base and isolated structures under blast loading

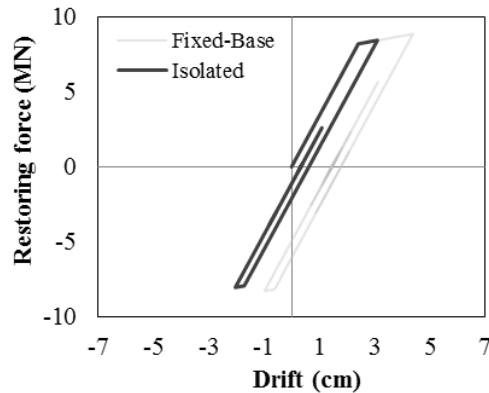

Figure 6. Hysteretic loops for the first story of fixed-base and isolated structures under blast loading

### 5.2 Effect of base isolation system properties on blast performance of isolated structure

Studying the effect of design variables of a control system can be useful for achievement of the best possible performance and identification of design variables having a significant impact on the performance of structure. Although the effect of base isolation system properties on the seismic responses of structures has been presented in previous researches [18], their effect has been not investigated under blast loading. Hence in this section, the effect of base mass and base stiffness on the blast response of structure is studied.

#### 5.2.1 Effect of base mass

In this section, the effect of base mass on the blast response of structure equipped with the base isolation system is studied assuming three different values for the base stiffness which the peak base drift and the peak story drift have been shown in Fig. 8.

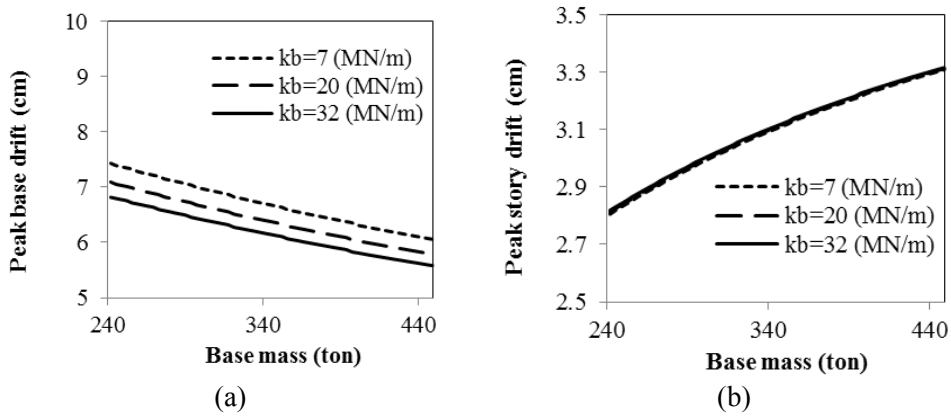

Figure 7. (a): Peak base and (b): Story drifts versus base mass

As shown in Fig. 8, the base mass has a significant impact on the blast response of isolated structure. The peak base drift and the peak story drift respectively decreases and increases with the increase of base mass. Hence in this case study, the greatest and lowest values of base mass can be considered as appropriate values to control the base drift and the story drift, respectively; and for simultaneous control, an appropriate value of base mass can be determined based on the relative importance of base drift and story drift.

5.2.2 Effect of base stiffness

The stiffness of base isolation system is known as an important factor in the seismic performance of structures. In this section, the effect of base stiffness on the blast performance of structure is investigated. To this end, the blast response of the isolated structure has been determined for different values of base stiffness that its results have been presented Fig. 9. The results show that in this case study, the peak base drift of isolated structure decreases with the increase of base stiffness whereas the peak story drift is almost independent of base stiffness.

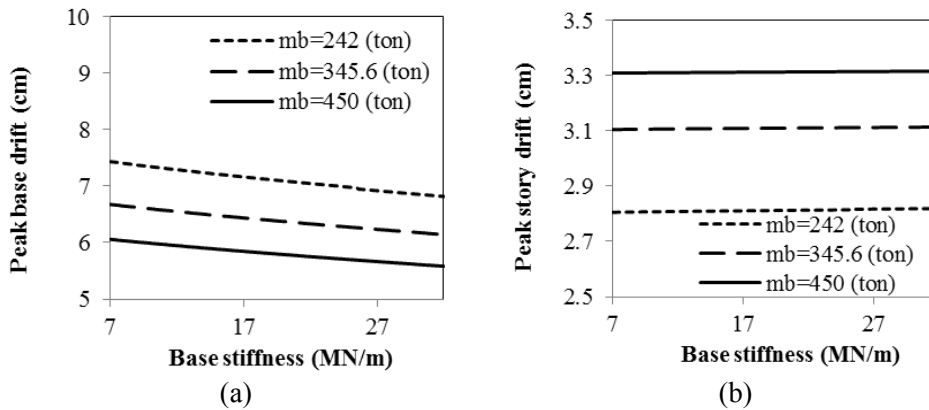

Figure 8. (a): Peak base and (b): Story drifts versus base stiffness

### 5.3 Blast-based optimal design of base isolation system

In previous section, the effect of design variables on the blast performance of isolated structure was investigated. Although a well-designed base isolation system can be achieved following a sensitivity analysis similar to previous section, this design method will have a high computational cost and also, the designed control system can not be confidently considered as an optimal design. In order to achieve an optimal base isolation system under blast loading, a method has been proposed for optimal determination of design variables via transforming the design problem into an optimization problem as explained in section 4. The defined optimization problem can be rewritten as follow according to the results of section 5.1:

Find

$$P = (m_b, k_b) \quad (12a)$$

minimize

$$f_{blast} = \alpha \frac{\max(d_b)_{blast}}{6.56} + (1 - \alpha) \frac{\max(d_1, d_2, \dots, d_n)_{blast}}{3.107} \quad (12b)$$

subject to

$$240 \leq m_b \leq 450(\text{ton}) \quad (12c)$$

$$7 \leq k_b \leq 32(\text{kN} / \text{m}) \quad (12d)$$

These constraints have been defined based on the variation domains considered in section 4. The defined optimization problem has been solved for different values of  $\alpha$  by using the genetic algorithm (GA). The procedure of solving this optimization problem is explained for  $\alpha=1$  and for other values of  $\alpha$ , the design procedure is quite similar.

To solve the optimization problem, the problem is first converted to an unconstrained optimization problem according to the penalty method [22] whereas parameters and operators of GA have been selected as explained in Mohebbi et al. [23]. The algorithm starts with an initial population of design variables composed of 50 randomly generated vectors  $P(m_b, k_b)$ . The blast performance of system is evaluated for each set of generated  $P$  vector and the blast responses of structure in terms of the peak story drift and the peak base drift are determined. Then, the objective function value is calculated for each set. In each generation, a number of the fittest sets ( $N_{elites}=5$ ), carrying the best values of objective function, are recognized as elite by monitoring the objective function and transferred to the next generation directly. The new generations are produced by a combination from these elites and a population generated by mating and mutating the individuals of previous generation until convergence is ultimately achieved. Different runs of GA with different initial populations are carried out in order to reach the global minimum and ensure the optimization accuracy. The convergence of the best values of objective function towards an optimum answer for three different runs has been shown in Fig. 10. It can be seen that although the convergence speeds have been different for different runs, almost the same optimum answer has been obtained for all runs.

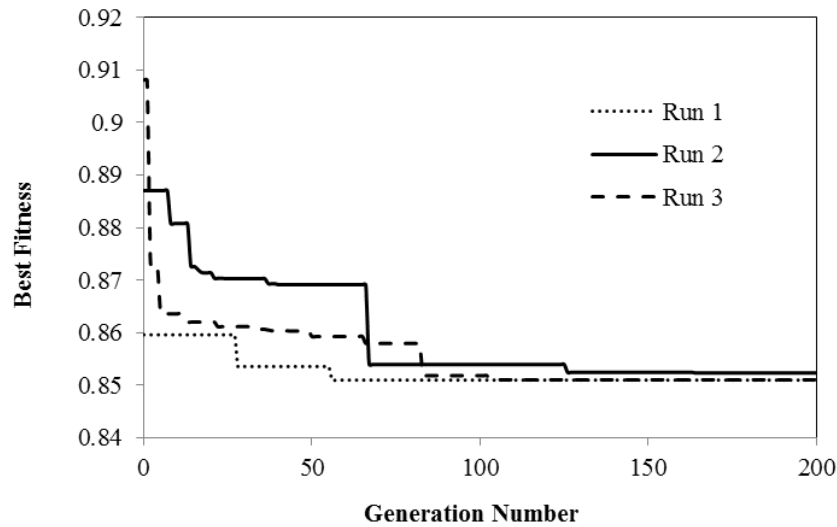

Figure 9. Convergence toward optimum answer for different runs of GA

Table 3: Optimum design results under blast loading

Design Results		$\alpha=1$	$\alpha=0.8$	$\alpha=0.5$	$\alpha=0.2$	$\alpha=0$
Optimum Design	$m_b$ (ton)	449.1	449.8	449.8	243.2	240.0
Variables	$k_b$ (MN/m)	32.0	31.7	31.8	31.9	7.0
	$d_b$	5.58	5.58	5.58	6.81	7.45
	$d_1$	3.32	3.32	3.32	2.82	2.80
	$d_2$	2.39	2.39	2.39	2.12	2.33
	$d_3$	2.02	2.02	2.02	1.70	1.90
Peak Drift (cm)	$d_4$	1.64	1.64	1.64	1.42	1.43
	$d_5$	1.30	1.30	1.30	1.31	1.23
	$d_6$	1.39	1.39	1.39	1.33	1.26
	$d_7$	1.39	1.40	1.40	1.01	0.92
	$d_8$	1.94	1.94	1.94	1.46	1.63

The optimum values of design variables and the peak blast responses of structure have been presented in Table 3 for different values of  $\alpha$ . As instance, the peak story drift of isolated structure is 2.80 (cm) for  $\alpha=0$  whereas corresponding value was 4.39 (cm) in the fixed-base structure. Therefore it can be concluded that 36.2% reduction in the peak story drift of the fixed-base structure has been achieved and the base isolation system designed using the proposed method can effectively mitigate the response of structure under blast loading. Also, 14.9% reduction in the peak base drift with respect to the base isolation system designed using the common seismic design approach (section 5.1) has been reached for  $\alpha=1$ . Therefore it can be concluded that under blast loading, the proposed design method is more effective than the common seismic design approach in controlling the blast response of isolated structure. For the multi-objective design, the parameter  $\alpha$  should be defined based

on the relative importance of base drift and story drift. As instance, a well-multi-objective design is obtained for  $\alpha=0.2$  as shown in Table 3. Therefore, it can be concluded that the proposed design method is effective in the optimal design of base isolation system and the achievement of different design objectives.

## 6. CONCLUSIONS

In this study, a method has been proposed for designing base isolation system to protect strategic structures against explosion due to terrorist attacks. This method is based on transforming the design problem into an optimization problem whereas the control system properties such as the base mass and the base stiffness have been considered as design variables and a linear combination of base drift and inter-story drift of isolated structure under blast loading has been defined as objective function. To illustrate the effectiveness of proposed method, base isolation system has been designed for controlling an eight-story shear frame under blast loadings. In this regard, a sensitivity analysis has been first conducted to study the effect of base isolation system characteristics on the blast responses of structure. The results show that the base mass has a significant effect on the blast responses of structure whereas the effect of base stiffness on the blast response of isolated structure is not considerable. The optimization results show that the base isolation system designed using the proposed design method leads to a considerable reduction in the response of structure under blast loading. As instance, 36.2% reduction in the peak story drift of fixed-base structure has been obtained by using the base isolation system designed with the objective of minimizing the peak story drift. For comparison objectives and validating the proposed design method, the performance of earthquake-based designed base isolation system has been also evaluated under blast loading. The results show that although the earthquake-based designed base isolation system has an acceptable performance under blast loading, the base isolation system designed using the proposed method works more effective in mitigating the blast response of structure. Therefore, it can be concluded that the proposed optimal design method is an effective design approach for base isolation system under blast loading.

## REFERENCES

1. Jangid R. Optimum lead-rubber isolation bearings for near-fault motions, *Eng Struct* 2007; **29**(10): 2503-13.
2. Pourzeynali S, Zarif M. Multi-objective optimization of seismically isolated high-rise building structures using genetic algorithms, *J Sound Vib* 2008; **311**(3-5): 1141-60.
3. Greco R, Marano GC. Robust optimization of base isolation devices under uncertain parameters, *J Vib Control* 2016; **22**(3): 853-68.
4. Mohebbi M, Dadkhah H. Optimal smart base isolation system for multiple earthquakes, *Int J Optim Civil Eng* 2019; **9**(1): 19-37.
5. Nourzadeh DD, Humar J, Braimah A. Comparison of response of building structures to blast loading and seismic excitations, *Procedia Eng* 2017; **210**: 320-25.

6. Nassr AA, Razaqpur AG, Tait MJ, Campidelli M, Foo S. Experimental performance of steel beams under blast loading, *J Perform Constr Fac* 2011; **26**(5): 600-19.
7. Ding Y, Song X, Zhu H-T. Probabilistic progressive collapse analysis of steel frame structures against blast loads, *Eng Struct* 2017; **147**: 679-91.
8. Saleh A, Adeli H. Optimal control of adaptive building structures under blast loading, *Mechatronics* 1998; **8**(8): 821-44.
9. Coffield A, Adeli H. An investigation of the effectiveness of the framing systems in steel structures subjected to blast loading, *J Civ Eng Manag* 2014; **20**(6): 767-77.
10. Cao L, Lu S, Laflamme S, Quiel S, Ricles J, Taylor D. Performance-based design procedure of a novel friction-based cladding connection for blast mitigation, *Int J Impact Eng* 2018; **117**: 48-62.
11. Zhang R, Phillips BM. Performance and protection of base-isolated structures under blast loading, *J Eng Mech* 2015; **142**(1): 04015063.
12. Mohebbi M, Dadkhah H. Performance of semi-active base isolation systems under external explosion, *Int J Struct Stab Dyn* 2017; **17**(10): 1750112.
13. Bulson PS. *Explosive Loading of Engineering Structures*, CRC Press, 2002.
14. Unified Facilities Criteria. *Structures to Resist the Effects of Accidental Explosions*, UFC 3-340-02 2008.
15. Kumar M, Whittaker AS, Constantinou MC. An advanced numerical model of elastomeric seismic isolation bearings, *Earthq Eng Struct Dyn* 2014; **43**(13): 1955-74.
16. Naeim F, Kelly JM. *Design of Seismic Isolated Structures: From Theory to Practice*, John Wiley & Sons, 1999.
17. Constantinou M, Whittaker A, Fenz D, Apostolakis G. *Seismic Isolation of Bridges*, University at Buffalo, Report to Caltrans for contract 65A0174, 2007.
18. Matsagar VA, Jangid R. Influence of isolator characteristics on the response of base-isolated structures, *Eng Struct* 2004; **26**(12): 1735-49.
19. Yang J, Long F, Wong D. Optimal control of nonlinear structures, *J Appl Mech* 1988; **55**(4): 931-38.
20. Wu C, Hao H. Safe scaled distance for masonry infilled RC frame structures subjected to airblast loads, *J Perform Constr Fac* 2007; **21**(6): 422-31.
21. Bisch P, Carvalho E, Degee H, et al. Eurocode 8: *Seismic Design of Buildings Worked Examples*, Luxembourg: Publications Office of the European Union, 2012.
22. Rao SS. *Engineering Optimization: Theory and Practice*, John Wiley & Sons, 2009.
23. Mohebbi M, Dadkhah H, Rasouli Dabbagh H. A genetic algorithm-based design approach for smart base isolation systems, *J Intell Mater Syst Struct* 2018; **29**(7): 1315-32.